

# GROUND ZERO<sup>®</sup>

## GERMAN ENGINEERING

---

# RADIOACTIVE-SERIES AMPLIFIER

## OWNER'S MANUAL

# GZRA 1.1650DX

### Features

- 1 Ohm stable
- Linkable 2 Ohm
- Mosfet power supply
- Power and protection indicator
- Variable 12dB Bass boost (45Hz)
- Phaseshift 0 / 180° (Switch)
- Variable Subsonic
- Variable Lowpass
- Adjustable input sensitivity
- Soft delayed remote turn on
- Stereo RCA output
- Bass remote control
- Thermal / Short / Overload protection

## Tools and materials you need

- Screwdriver
- Electric drill, 3 mm / 0.12" carbide drill bit
- Mounting screws
- Power wire min. 25 mm<sup>2</sup> / 4 AWG
- Ground wire min. 25 mm<sup>2</sup> / 4 AWG
- Speaker wire min. 2 x 2,5 mm<sup>2</sup>

## Please note!

- As a precaution it is advisable to disconnect the vehicle's battery before making connection to the +12 Volts supply wiring (see owner's manual of your car for further information).
- Please use great caution drilling your trunk. Your gas tank and brake lines can be damaged by puncturing with your drill bit – this could cause damage or failure of your cars operating systems.
- Never pass wires over sharp angles. It is recommended to buffer the power supply of the amplifier with an additional capacitor (power cap) min. 1 F to guarantee a stable operation voltage.

### **WARNING !**

High powered audio systems in a vehicle are capable of generating "Live Concert" levels of sound pressure. Continued exposure to excessively high volume sound levels may cause hearing loss or damage. Also, operation of a motor vehicle while listening to audio equipment at high volume levels may impair your ability to hear external sounds such as; horns, warning signals, or emergency vehicles, thus constituting to a potential traffic hazard. In the interest of safety, Consumer Electronics recommends listening at lower volume levels while driving.

## Planning your system

Before beginning the installation, consider the following:

- a) If you plan to expand your system by adding other components sometime in the future, ensure adequate space is left, and cooling requirements are met.
- b) If your radio is equipped with preamplifier outputs (RCA), it is advisable to use them.

## Mounting your amplifier

- a) Select a suitable location that is convenient for mounting, is accessible for wiring and has ample room for air circulation and cooling.
- b) Use the amplifier as a template to mark the mounting holes, remove the amplifier and drill 4 holes. Then mount the amplifier with the mounting screws.

## Warning

Choose a mounting position where all electric wires are protected from being damaged by sharp edges, heat or other conditions. +12Volt DC electrical connections must be fused on the battery side. Make sure your radio and all other devices will be turned off while connection your system.

If you need to replace the power fuse, replace it only with a fuse identical to that supplied with the system. Using a fuse of different type or rating may result in damage to this system which isn't covered by the warranty.

## Power connection

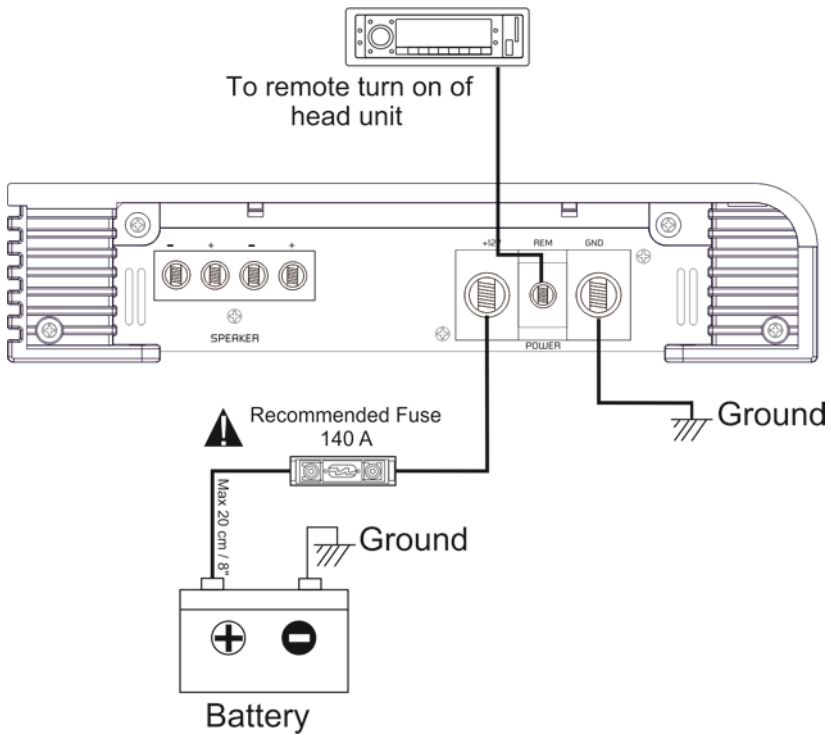

## Controls and functions

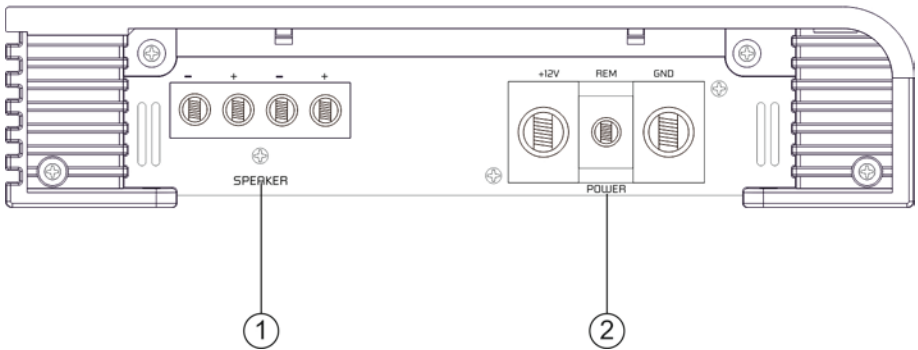
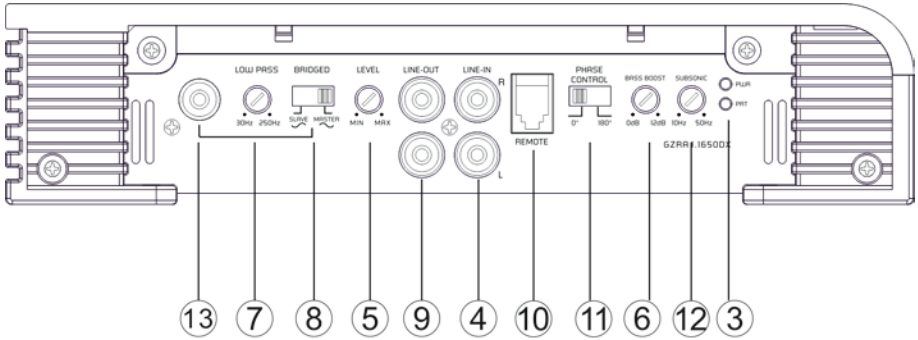

## Control and functions

1	<b>Speaker terminals</b>	For connection of the subwoofer
2	<b>Power terminals</b>	GND -> Ground connection REM -> Remote antenna terminal BATT -> +12 Volt
3	<b>Status indication</b>	GREEN – OK RED – Error
4	<b>Cinch inputs</b>	Terminal for connection of the RCA wires. To avoid failure, please use high quality RCA wires.
5	<b>Input level controller</b>	With this controller you can adjust the input sensitivity.
6	<b>Bass boost controller</b>	For adjusting of the bass boost level in the range from 0 to +12 dB.
7	<b>Low pass controller</b>	Adjust the variable lowpass frequency to the desired frequency between 30 and 250 Hz using the controller.
8	<b>Master / Slave Switch</b>	For choosing the operation mode of each amplifier in link mode.
9	<b>Cinch Outputs</b>	For connection of additional amplifiers in fullrange operation.
10	<b>Remote control input</b>	For connection of the bass remote control.
11	<b>Phase shift controller</b>	This controller allows you to fit the subwoofer channel in-phase to the front system.
12	<b>Subsonic controller</b>	This controller allows you to filter low frequencies in a range between 10 and 50 Hz. This function reduces the mechanical Xmax and raises the capacity of the connected subwoofer.
13	<b>Master/Slave Cinch-In-/Output</b>	Cinch In- / Output for operation of two same amplifiers in linkmode.

## Turning on the amplifier

The amplifier automatically turns on a few seconds after you turn on your radio.

Note: Your amplifier temporarily shuts down if it gets too hot, then restarts automatically once it cools

(At about 80° / 176° F).

## Adjusting the audio level

1. LEVEL (Min/Max): Turn fully counter- clockwise to MIN position
2. Turn the auto sound system's volume control to about two-third of its full range.
3. Adjust LEVEL to a comfortable listening level.

## 2 Woofer wiring

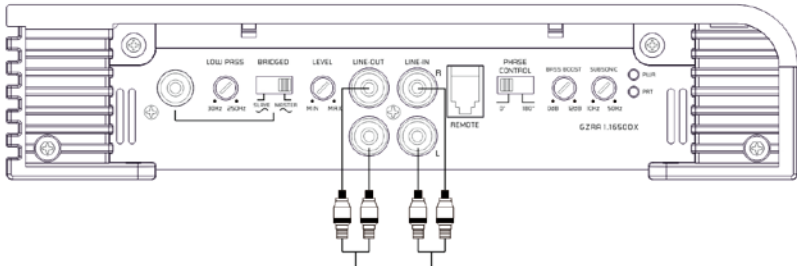

Zum Input weiterer Verstärker / To input additional /  
Entrée des amplificateurs additionnelle / Naar de  
aansluiting van ander versterker

Zum Line Out des Autoradios / To car stereo line out /  
Sortie stéréo de la voiture / Naar line out radio

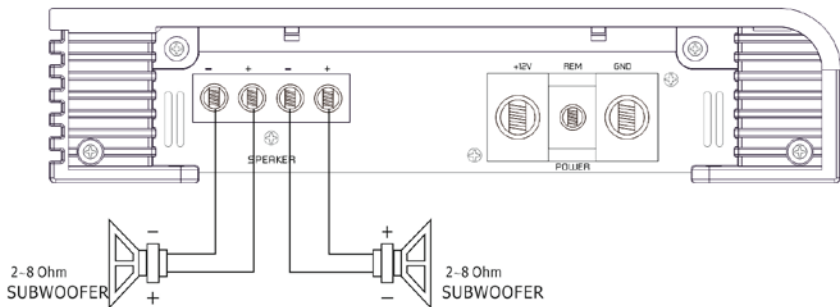

Lautsprecher Impedanz / Speaker impedance / Impédance haut parleur / Luidspreker impedantie  
**2 ~ 8 Ohm**

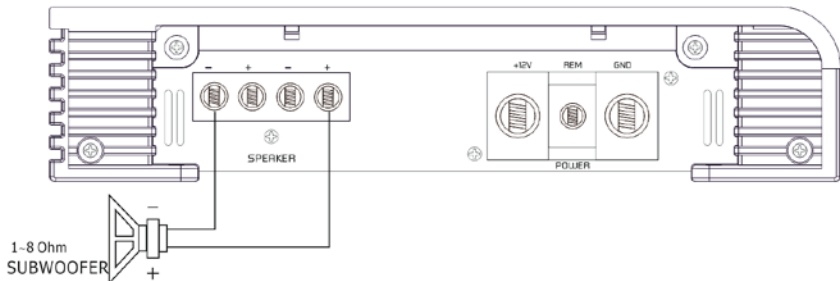

Lautsprecher Impedanz / Speaker impedance / Impédance haut parleur / Luidspreker impedantie  
**1 ~ 8 Ohm**

# Master & slave wiring

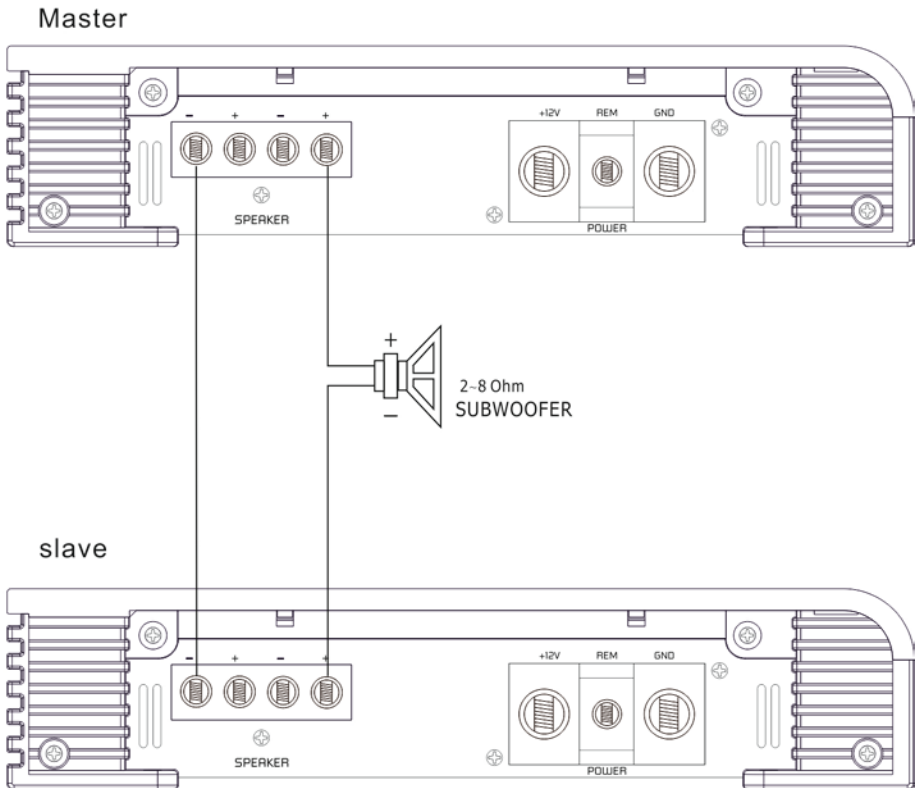

# Master & slave wiring

Master

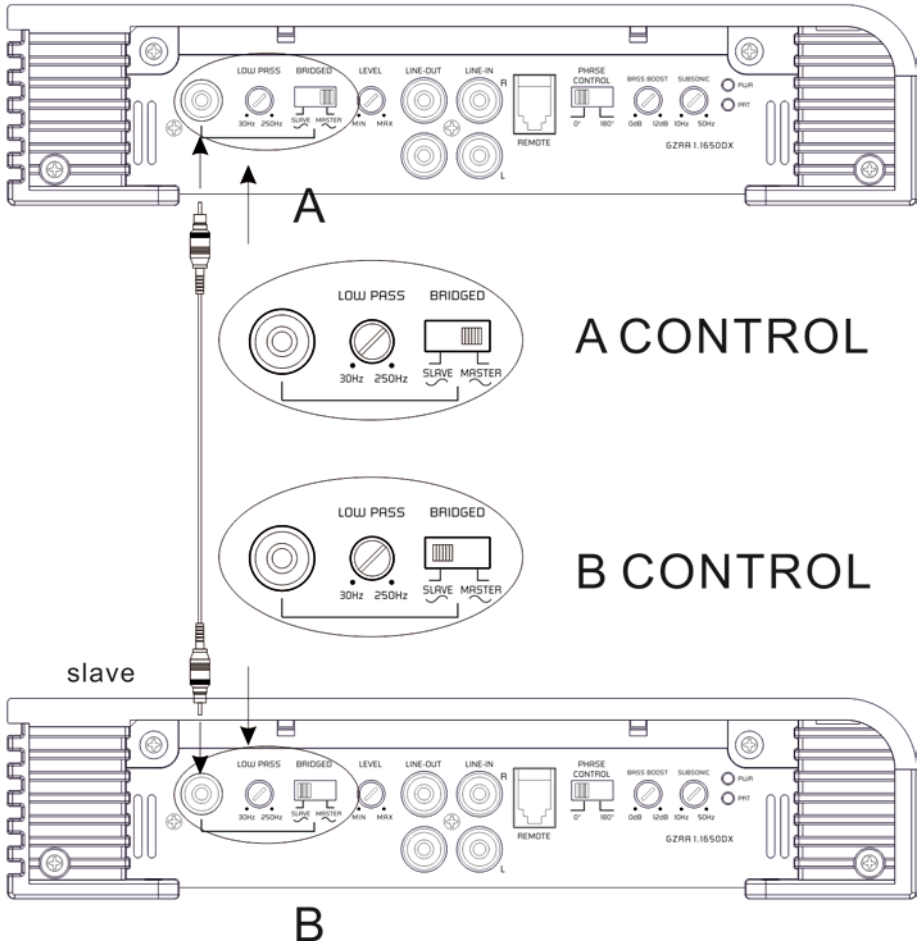



## Specifications

<b>Model</b>	<b>GZRA 1.1650DX</b>
<b>Type</b>	1 Channel Class D
<b>RMS Power @ 4 <math>\Omega</math></b> CEA Standard CEA-2006-A	1 x 650 W (1% THD+N) 1 x 800 W (10% THD+N)
<b>RMS Power @ 2 <math>\Omega</math></b> CEA Standard CEA-2006-A	1 x 1250 W (1% THD+N) 1 x 1400 W (10% THD+N)
<b>RMS Power @ 1 <math>\Omega</math></b> CEA Standard CEA-2006-A	1 x 1800 W (1% THD+N) 1 x 2300 W (10% THD+N)
<b>RMS Power @ 2<math>\Omega</math> Linkmode</b> CEA Standard CEA-2006-A	1 x 3600 W (1% THD+N) 1 x 4600 W (10% THD+N)
<b>Damping factor</b>	> 100
<b>Signal to noise Ratio</b>	> 75 dB
<b>Lowpass</b>	30 Hz – 250 Hz
<b>Subsonic filter</b>	10 Hz – 50 Hz
<b>Bass boost</b>	0 ~ +12 dB (45 Hz)
<b>Frequency response</b>	10 Hz – 250 Hz ( $\pm$ 1 dB)
<b>Input sensitivity</b>	200 mV – 9 V ( $\pm$ 5%)
<b>Bass remote control</b>	✓
<b>Fuse</b>	4 x 35A
<b>Dimensions</b> W x H x L mm	230 x 53 x 446
<b>Dimensions</b> W x H x L inch	9.04" x 2.09" x 17.56"

## Trouble shooting guide

Symptoms	Check Points	Cure
No sound	Is the POWER LED illuminated?	Check fuses in amplifier. Be sure remote lead is connected. Check +12 Volt connection Check ground connection
	Is the diagnostic LED illuminated?	Check for speaker short or amplifier overheating
Amp not switching on	No power to the amplifier	Check power wire or connections
	No power to remote wire with receiver on	Check connections to radio
No sound in one channel	Check speaker leads	Inspect for short circuit or an open connection
	Check audio leads	Reverse left and right RCA inputs to determine if it is occurring before the amp
Amp turning off at medium / high volume	Check speaker load impedance	Be sure proper speaker load impedance recommendations are observed (If you use an ohm meter to check speaker resistance, please remember that DC resistance and AC impedance may not be the same.)
Protection LED is on	Temperature shut down	Turn radio volume down
	Speaker wires short	Separate speaker wires and insulate

Die Gewährleistung entspricht der gesetzlichen Regelung. Eine Rücksendung kann nur nach vorheriger Absprache und in der Originalverpackung erfolgen. Bitte unbedingt einen maschinell erstellten Kaufbeleg und eine Fehlerbeschreibung beilegen. Von der Gewährleistung ausgeschlossen sind Defekte, die durch Überlastung, unsachgemäße Behandlung oder bei Teilnahme an Wettbewerben entstanden sind. Wir behalten uns das Recht vor, zukünftig nötige Änderungen oder Verbesserungen an dem Produkt vorzunehmen ohne den Kunden darüber zu informieren.

Limited warranty - defective products must be returned in original packaging - please add a copy of the original purchasing invoice showing the purchasing date and a detailed description of the failure. Failure caused by overload, misuse or by using the product for competition purpose are not covered by the warranty. We reserve the right to make needed change or improvement to the product without informing customer about this in advance.

De Garantie bepalingen van alle door ground zero geleverde producten is volgens wettelijke bepalingen geregeld. Een retourzending kan alleen na duidelijke afspraak en in de originele verpakking plaatsvinden. SVP een aankoopbon en een duidelijke storingsomschrijving bijvoegen. Van garantie uitgesloten zijn defecten door overbelasting, onkundig gebruik, of door deelname aan wedstrijden (SPL) ontstaan zijn. Wij behouden ons het recht om de nodige veranderingen of verbeteringen aan het product door te voeren zonder de klant hierover te informeren.

La garantie est conforme aux droits légaux. Un retour du produit défectueux doit être dans son emballage d'origine sur présentation du reçu ou de la facture indiquant la description du défaut. La présente Garantie n'est pas applicable lorsque le produit a été endommagé en raison: Mauvaise alimentation, Trop de puissance (HP, Subwoofer) Accident, Installation ou Utilisation non conforme aux normes Technique (Concours SPL etc). Nous nous réservons le droit d'entreprendre à l'avenir nécessairement des modifications ou des améliorations au produit sans informer le client.

## Ground Zero GmbH

Erlenweg 25, 85658 Egming, Germany

Tel. +49 (0)8095/873 830 Fax -8310

[www.ground-zero-audio.com](http://www.ground-zero-audio.com)

